

A80R

MANUALE D'ISTRUZIONE GENERAL INSTRUCTION BOOK

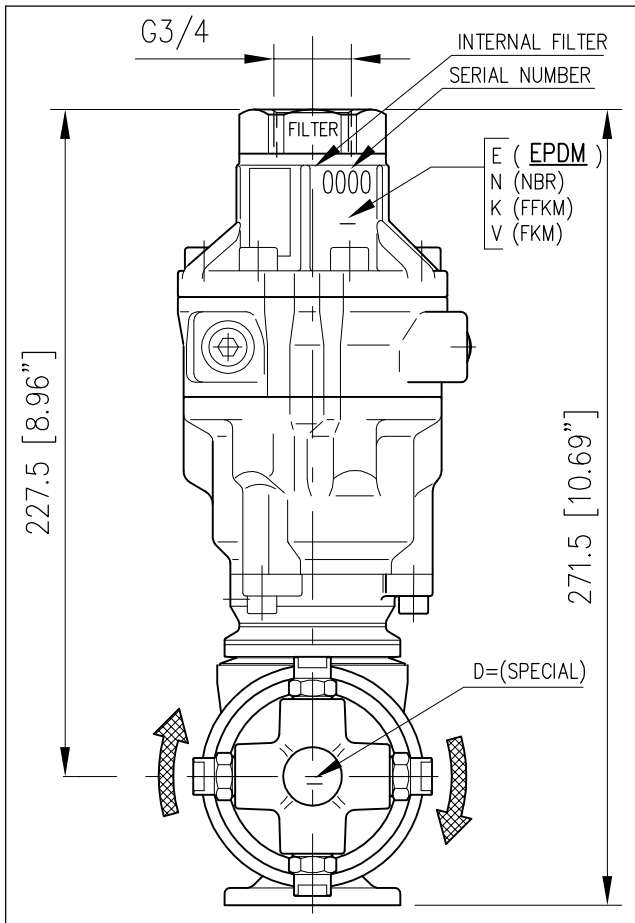

TESTINA AUTOMOVENTE PER PULIZIA CISTERNE

- Testina volumetrica, la velocità di rotazione è proporzionale alla portata in ingresso.
- Lavaggio superfici interne di contenitori e serbatoi.
- Portata ridotta, alta pressione, elevata forza di impatto.
- Copertura orbitale completa degli interni.
- Velocità di rotazione indipendente dalla temperatura dell'acqua.
- Filtro in entrata.
- Costruzione in acciaio inox.
- Idonea per impiego settore alimentare.

ATTENZIONE !

- La Testina STANDARD è fornita di guarnizioni (DINAMICHE) in PTFE + O-Ring **EPDM**.
- Lubrificare esclusivamente con **GRASSO SILICONICO** codice: 14.6552.00
- Per l'utilizzo di liquidi detergenti, additivi chimici ecc. non compatibili con le guarnizioni standard è indispensabile contattare il nostro UFFICIO TECNICO.
- A richiesta le guarnizioni (DINAMICHE) O-RING sono disponibili anche in diverso materiale, NBR-FFKM(kalrez)-FKM(viton).
- Le guarnizioni (STATICHE) sono in FKM (viton).

SELF ROTATING CLEANING HEAD

- This is a self-propelled tank cleaning head: when the flow rate increases, the head rotates faster.
- Cleaning of interior surfaces of tanks and drums.
- Reduced flow, high pressure, high cleaning impact.
- Complete orbital coverage of all interior surfaces.
- Rotating speed independent from water temperature.
- Inlet filter.
- Stainless steel construction.
- Suitable for utilization in food industry.

ATTENTION !

- The STANDARD Tank cleaning head is supplied with seals (DYNAMIC) in PTFE + O-Ring **EPDM**.
- Lubricate **ONLY** with **SILICONE GREASE** P/N: 14.6552.00
- For use with Detergent liquid, Chemical additives etc that are not compatible with the standard seals, it is essential to contact our TECHNICAL OFFICE for further information.
- On request, the O-RING seals (DYNAMIC) are available in different materials such as NBR-FFKM(kalrez)-FKM(viton).
- The STATIC seals are in FKM (viton).

Foro entrata minimo
in manuale
Minimum inlet hole
for manual operation

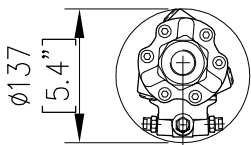

Foro entrata minimo
in automatico
Minimum inlet hole
for automatic operation

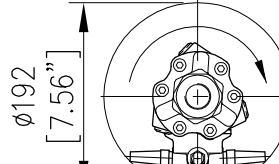
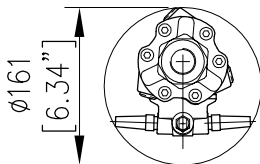
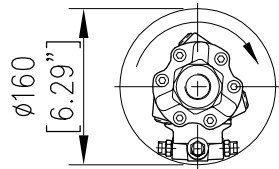

**ATTENZIONE: NON UTILIZZARE
L'APPARECCHIO PRIMA DI AVER LETTO
QUESTO MANUALE DI ISTRUZIONE**

**CAUTION: DO NOT USE THE
CLEANING HEAD BEFORE HAVING READ
THE INSTRUCTION BOOK**

CARATTERISTICHE TECNICHE TECHNICAL SPECIFICATIONS

A80-R



- PRESSIONE NOMINALE RATED PRESSURE	30÷140 bar - 3÷14 MPa (435-2000 psi)
- PRESSIONE CONSENTITA PERMISSIBLE PRESSURE	160 bar - 16 MPa (2300 psi)
- PORTATA MASSIMA MAX FLOW RATE	20 - 120 l/min (5.3-32 USGp.m.)
- TEMPERATURA MASSIMA ACQUA MAX WORKING TEMPERATURE	0-90°C (32-195°F)
- PESO WEIGHT	5.9 kg (208 oz)
- FREQUENZA ROTAZIONE ASSE PRINCIPALE MAIN AXIS ROTATING SPEED	10-16 giri/min (RPM)
- ATTACCO ALIMENTAZIONE ACQUA INLET CONNECTION SIZE	G 3/4"
- FILTRO IN INGRESSO INLET FILTER	550 µm
- ATTACCO UGELLI (2 o 4) NOZZLES CONNECTION (2 or 4)	1/4 NPT

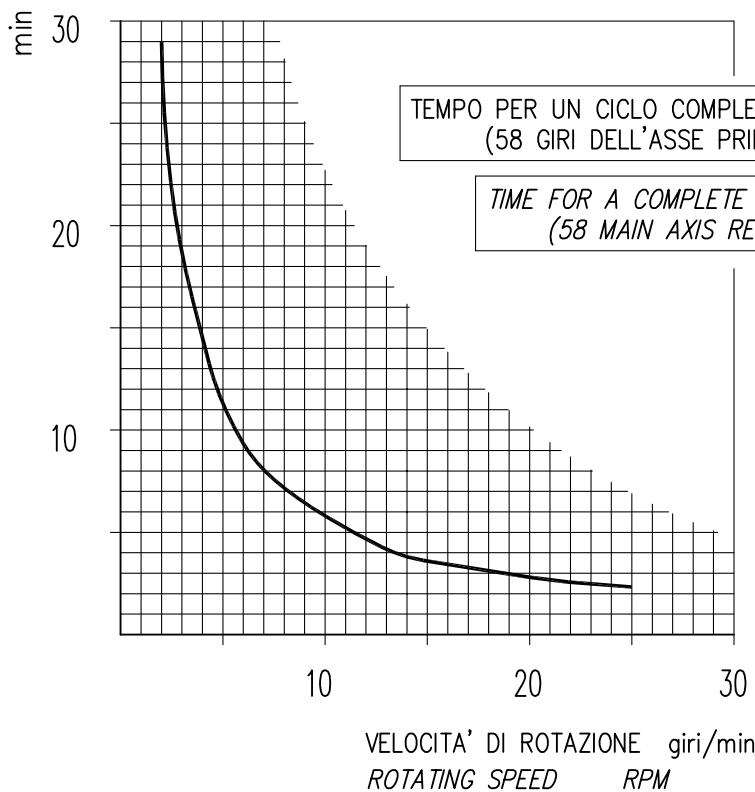

-D1-

VARIAZIONE DEI GIRI IN FUNZIONE DELLA PORTATA
RPM VARIATION IN RELATION TO FLOW

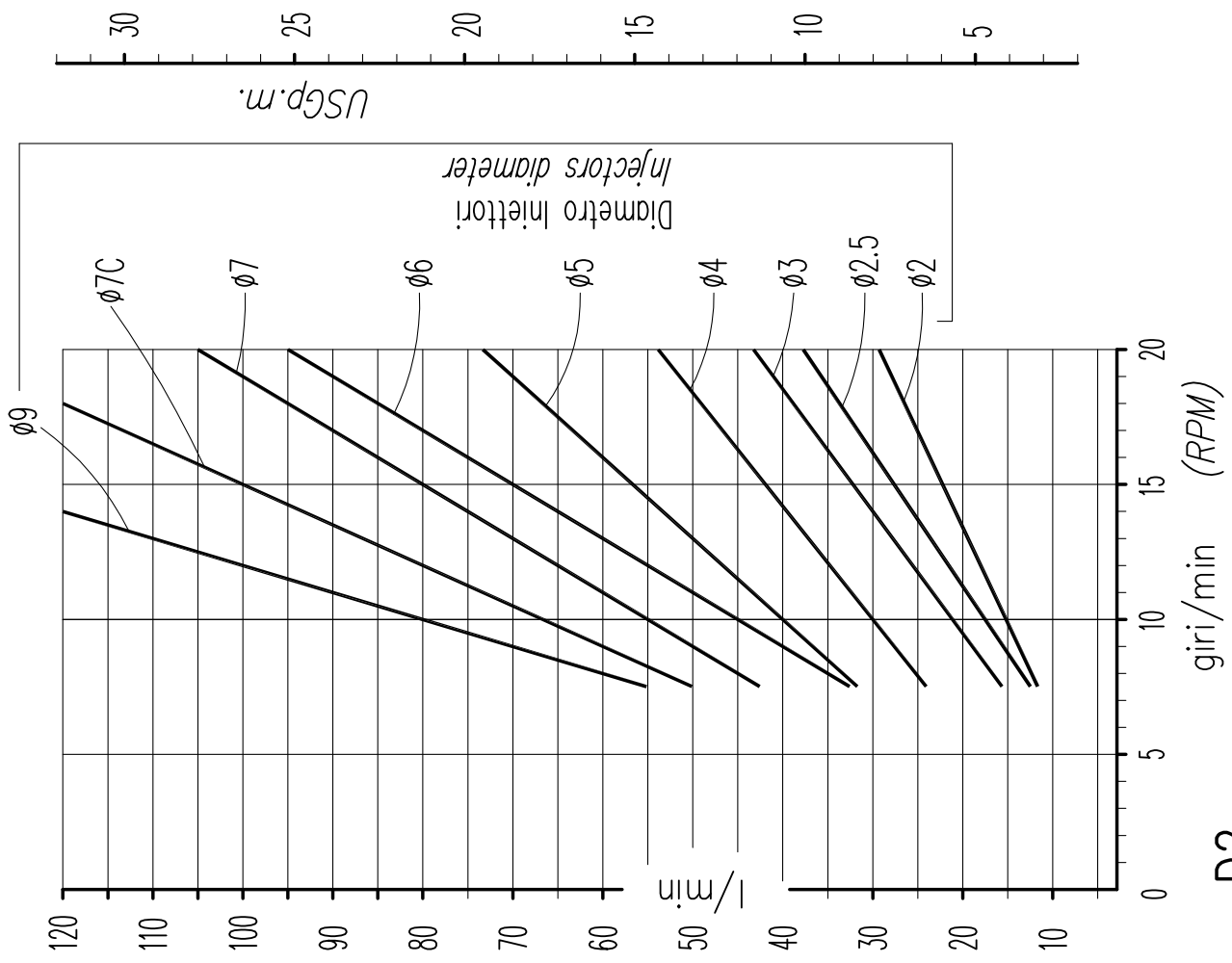

CADUTA DI PRESSIONE IN FUNZIONE DELLA PORTATA
LOSS OF PRESSURE IN RELATION TO FLOW

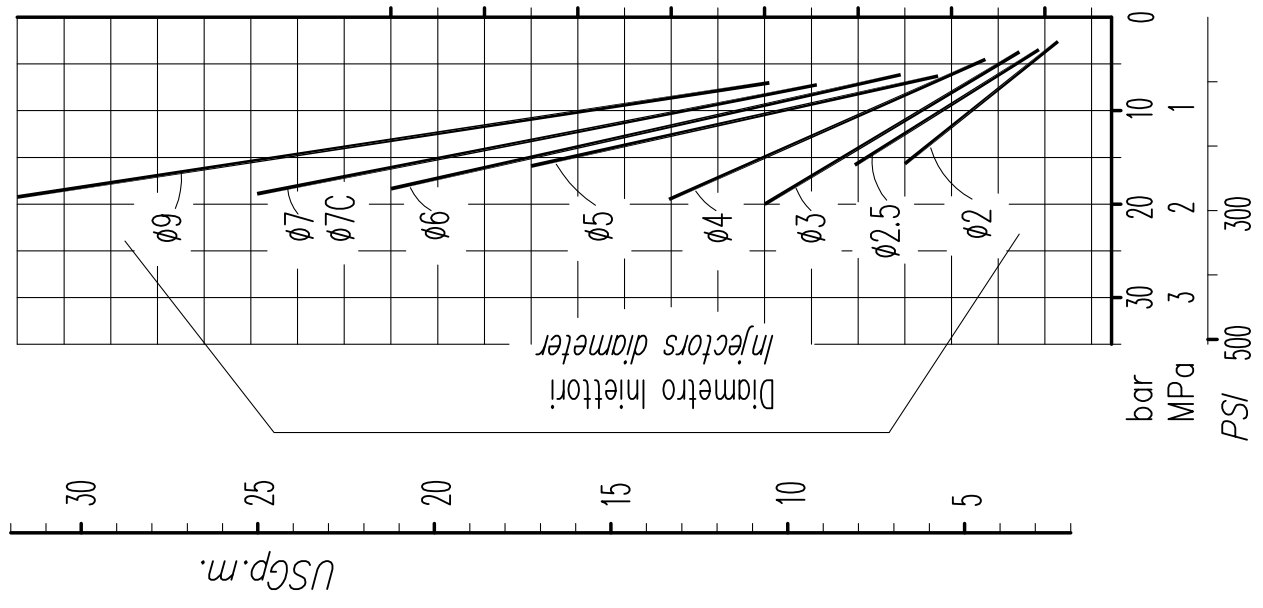



P.A. – S.p.A. – EQUIPAGGIAMENTI TECNICI DEL LAVAGGIO

VIA MILANO, 13 – CASELLA POSTALE 115 – 42048 RUBIERA (REGGIO EMILIA) – ITALY
 Tel. +39 0522 623611 – Fax. +39 0522 629600 – R.E.A. RE 156319 – R.I. RE11535 – Mecc. RE 013446
 C.F. e P. IVA 01035950359 – Cap. Soc. i.v. € 750.000,00 – Codice Identificativo C.E.E. IT 01035950359
 ART. 2497 – BIS C.C. DIREZIONE E COORDINAMENTO BENETTI srl R.I. TRIB. DI RE 01480690351
 Web: <http://www.pa-etl.it> – E-mail: info@pa-etl.it



Dichiarazione di conformità – Declaration of conformity

<i>Attrezzatura – Equipment:</i>		ACCESSORIO A PRESSIONE PRESSURE EQUIPMENT	
<i>Modello – Type:</i>		A80R - A80R2	
<i>Fluido – Fluid:</i>		ACQUA CALDA E DETERGENTI HOT WATER AND DETERGENTS	
<i>Gruppo fluidi: Group of Fluid:</i>	II	<i>Temperatura min. e max. ammissibile Permissible Temperature (min/max °C)</i>	0 ÷ 90°C

Procedura di valutazione della conformità

Conformity Assessment Procedure Followed

<i>Allegato: Annex:</i>		<i>Modulo: Module:</i>	
<i>Organismo notificato - Notified Body:</i>			-----
<i>Attestato CE del tipo - EC Type - Examination Certificate:</i>			-----
<i>Marcatura CE del fabbricante - Manufacturer's CE Marking:</i>			-----
<i>Organismo Notificato per il Sistema Qualità: Notified Body for Assessment of Quality System:</i>			-----
<i>Organismo di certificazione per il Sistema di Qualità: Notified Body for Certification of Quality System:</i>			DNV-GL
<i>Norme europee applicate: Harmonized Standards applied :</i>			CEI EN 60335-2-79:2015 UNI EN 1829-1:2010
<i>Codici di calcolo: Design Calculations Applied:</i>			

Libretto uso e manutenzione presente nel sito web <i>Operation and Maintenance Manual available on Website</i>	Il Fabbricante PA SpA <i>The Manufacturer PA SpA</i>	
--	--	--

25.4820.20 A80R Test.semov.iniett.2mm
 25.4820.25 A80R Test.semov.iniett.2,5mm
 25.4820.30 A80R Test.semov.iniett.3mm
 25.4820.40 A80R Test.semov.iniett.4mm
 25.4820.50 A80R Test.semov.iniett.5mm
 25.4820.60 A80R Test.semov.iniett.6mm
 25.4820.70 A80R Test.semov.iniett.7mm

25.4820.80 A80R Test.semov.iniett.7mm corto
 25.4820.90 A80R Test.semov.iniett.9mm
 25.4825.25 A80R testina, iniett.2,5mm, ug.diritti
 25.4825.60 A80R testina, iniett.6mm, ug.diritti
 25.4825.70 A80R testina, iniett.7mm, ug.diritti
 25.4826.60 A80R/6mm Testina ug.diritti-Viton

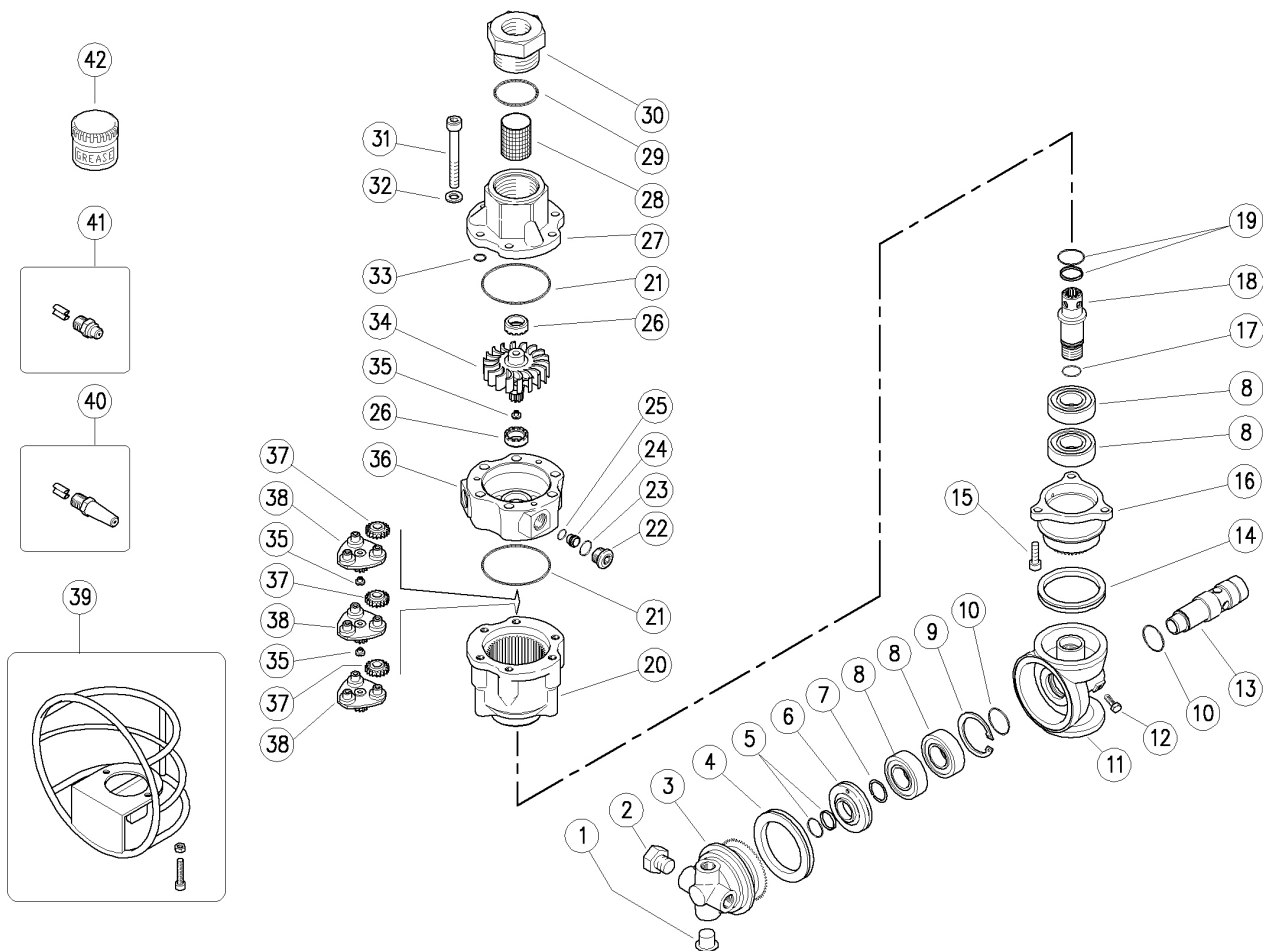

Pos.	Codice	Descrizione	Q.tà	K1	K2	K3	K4		Pos.	Codice	Descrizione	Q.tà	K1	K2	K3	K4	
1	15.3720.14	Tappo G1/4" plast.	2					4	24	80.0227.51	Iniettore 2,5mm inox (4) **	3					3
2	15.3721.14	Tappo inox 1/4M Npt s/testa	2					10	24	80.0222.51	Iniettore 3mm inox (5) **	3					3
3	80.0132.52	Pignone portaugelli z.58 4x1/4Npt F inox	1					1	24	80.0223.51	Iniettore 4mm inox (6) **	3					3
3	80.0134.52	Pignone p-ug. dir. z.58 4x1/4Npt F inox (1)	1					1	24	80.0224.51	Iniettore 5mm inox (7)	3					3
3	80.0134.52	Pignone p-ug. dir. z.58 4x1/4Npt F inox (2)	1					1	24	80.0225.51	Iniettore 6mm inox (8) **	3					3
4	10.2060.05	Anello V-ring 54x5 mm	1	•				5	24	80.0226.51	Iniettore 7mm inox (9) **	3					3
5	10.2030.16	Guarn. stelo 16x21x2,2 mm +OR Epdm	1	•				5	24	80.0228.51	Iniettore corto 7mm inox (10) **	3					3
5	10.2035.16	Guarn.16x21x2,1 mm +Or Vit. (2) **	1					5	25	10.3003.00	An.OR 1x8 mm	3	•				10
5	10.2033.16	Anello guarn.16mm+An.Or, kalrez **	1					1	26	80.0212.84	Boccola plastica	2		•			3
6	80.0211.51	An. distanziale 16x41,8x8,8mm inox	1					2	27	80.0201.52	Collettore inox	1					1
7	10.1021.00	An. elastico d.20x2 mm inox	1		•			5	28	28.0014.53	Rete 38mesh-400µm inox	1					10
8	11.4420.42	Cuscinetto 20x42x12 mm - 2RS1 inox	4		•			2	29	10.3208.36	An.OR 2,62x36,17 mm Vi 70	1	•				5
9	10.1025.05	An. elast. I 42 inox	1		•			5	30	80.0217.51	Racc. M40x2 M -G3/4F inox	1					1
10	10.3200.10	An.OR 2,62x23,47 mm Vi 70	2	•				10	31	16.1955.60	Vite DIN912 M8x60 mm inox	6					10
11	80.0135.52	Terminale albero dentato inox	1					1	32	14.3573.00	Rosetta sicur. 8,4x2 mm inox	6					10
12	16.1870.02	Vite DIN933 M5x12 mm inox	2					10	33	10.3109.93	An.OR 2,4x8,3 mm Vi 70	3	•				10
13	80.0242.51	Perno 24x85mm inox	1					1	34	80.0203.52	Turbina inox	1					1
14	10.2050.05	Anello V-ring 45x5 mm	1	•				2	35	80.0213.84	Perno rasamento plast.	3		•			3
15	16.1896.20	Vite DIN912 M6x20 mm inox	3					10	36	80.0202.52	Statore inox	1					1
16	80.0131.52	Pignone z.39 inox	1					1	37	80.0204.38	Satellite z.19 bronzo	9		•			3
17	10.3066.10	An.OR 1,78x15,6 mm Vi 70	1					10	38	80.0205.00	Portasatelliti+3 perni inox	3					1
18	80.0243.51	Albero terminale inox	1					1	39	25.4822.00	Protez. -A80 R -ug.prolun. **	1					1
19	10.2030.18	Guarn. stelo 18x23x2 mm +OR Epdm	1	•				5	40	80.0418.23	Ug. prol. inox 07 1/4M Npt+ventol. **	2-4					2
19	10.2035.18	Anello guarn.18mm -patt.+An.Or vit. (2) **	1					1	40	80.0420.23	Ug. prol. inox 09 1/4M Npt+ventol. **	2-4					2
19	10.2033.18	Anello gu.18mm -pat.+An.Or, kalrez **	1					1	40	80.0430.23	Ug. prol. inox 20 1/4M Npt +ventol. **	2-4					2
20	80.0207.52	Corona z.50 inox	1					1	40	80.0440.23	Ug. prol. inox 30 1/4M Npt +ventol.	2-4					2
21	10.3080.58	An.OR 1,78x56,87 mm Vi 70	2	•				10	41	16.1380.45	Ug. inox 1/4M Npt+ventol. 00.045 ***	2-4					10
22	80.0219.51	Tappo EI M14x1 inox	3			•		3	42	14.6552.00	Grass.silicone-teflon-30g.>tutti imp. **	1					2
23	10.3060.10	An.OR 1,78x12,42 mm Vi 70	3	•		•		10	42	14.6550.00	Grasso al teflon x30 g.>no Epdm **	1					2
24	80.0221.51	Iniettore 2mm inox (3) **	3					3									

** Su richiesta

*** Varie misure disponibili

Kit	Codice	Descrizione	
K1	25.4828.24	Kit ric.guarn. A80R 10x1pz.	1
K2	25.4852.24	Kit ric. A80R 7x1pz.	1
K3	25.4810.40	A80 kit iniettori 4,00mm+tappi	1

(1) 25.4825.25 (2) 25.4826.60 (3) 25.4820.20 (4) 25.4820.25 (5) 25.4820.30 (6) 25.4820.40 (7) 25.4820.50 (8) 25.4820.60 (9) 25.4820.70 (10) 25.4820.80

- 25.4820.20 A80R Tank clean.,s/prop.,2mm inject.
- 25.4820.25 A80R Tank clean.,s/prop.,2,5mm inject.
- 25.4820.30 A80R Tank clean.,s/prop.,3mm inject.
- 25.4820.40 A80R Tank clean.,s/prop.,4mm inject.
- 25.4820.50 A80R Tank clean.,s/prop.,5mm inject.
- 25.4820.60 A80R Tank clean.,s/prop.,6mm inject.
- 25.4820.70 A80R Tank clean.,s/prop.,7mm inject.

- 25.4820.80 A80R Tank clean.,s/prop.,7mm short inj.
- 25.4820.90 A80R Tank clean.,s/prop.,9mm inject.
- 25.4825.25 A80R Tank cl.,2,5mm inject,strght nozzl.
- 25.4825.60 A80R Tank cl.,6mm inject,straight nozzl.
- 25.4825.70 A80R Tank cl.,7mm inject,straight nozzl.
- 25.4826.60 A80R/6mm Clean.head,strgt.nozzles-Viton

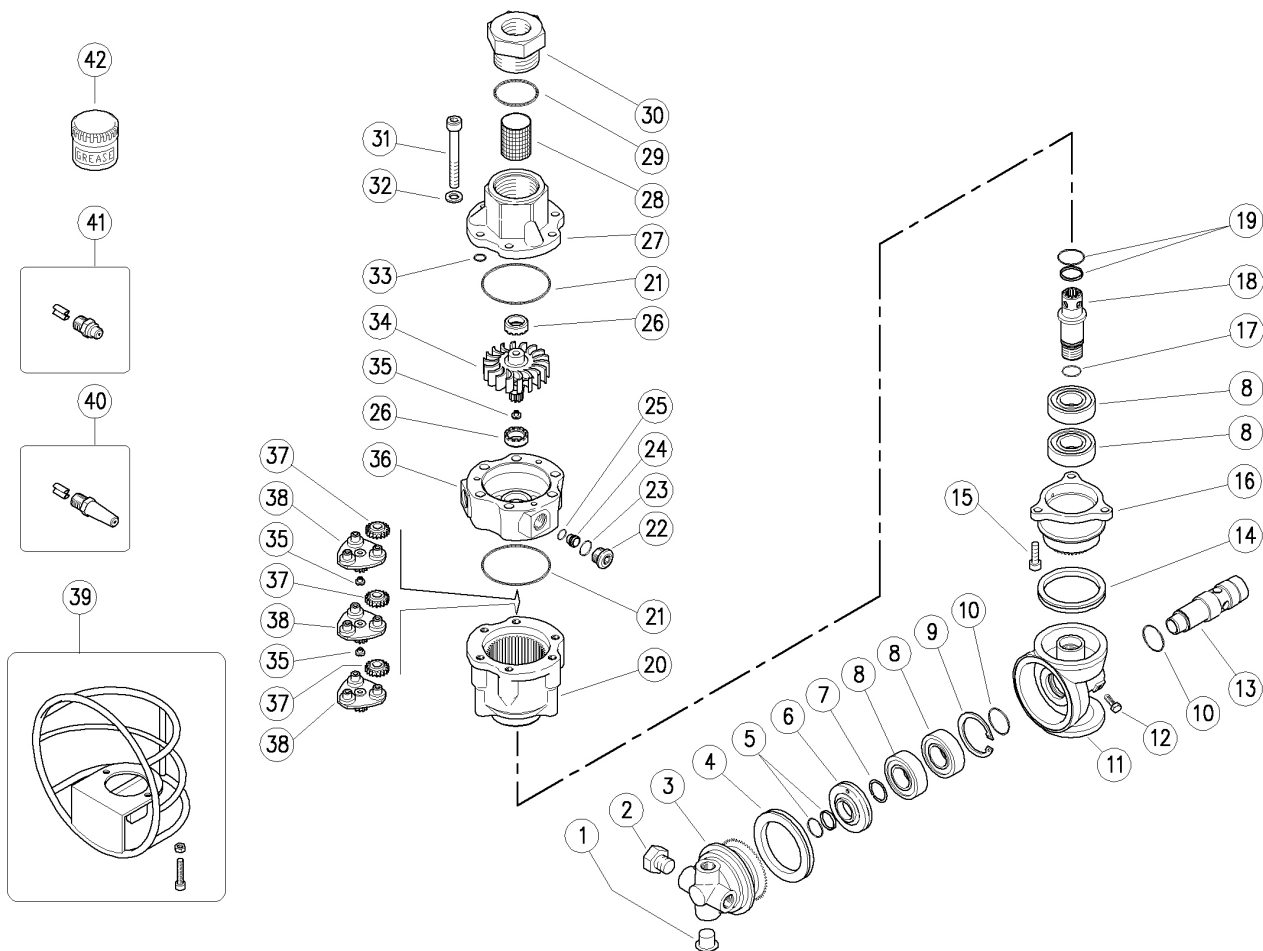

Pos.	P/N	Description	Q.ty	K1	K2	K3	K4		Pos.	P/N	Description	Q.ty	K1	K2	K3	K4	
1	15.3720.14	Plug, 1/4" Bsp plast.	2					4	24	80.0227.51	Injector, 2,5mm Sst. (4) **	3					3
2	15.3721.14	Grub screw, Sst. 1/4M Npt	2					10	24	80.0222.51	Injector, 3mm Sst. (5) **	3					3
3	80.0132.52	Nzl hold. pinion, z.58 4x1/4Npt F Sst.	1					1	24	80.0223.51	Injector, 4mm Sst. (6) **	3					3
3	80.0134.52	Strght.nzl hold.pinion,z.58 4x1/4Npt F (1)	1					1	24	80.0224.51	Injector, 5mm Sst. (7)	3					3
3	80.0134.52	Strght.nzl hold.pinion,z.58 4x1/4Npt F (2)	1					1	24	80.0225.51	Injector, 6mm Sst. (8) **	3					3
4	10.2060.05	V-ring seal, 54x5 mm	1	•				5	24	80.0226.51	Injector, 7mm Sst. (9) **	3					3
5	10.2030.16	Stem seal, 16x21x2,2 mm +O-ring Epdm	1	•				5	24	80.0228.51	Short injector, 7mm Sst. (10) **	3					3
5	10.2035.16	Seal, 16x21x2,1 mm+Or.iVit. (2) **	1					5	25	10.3003.00	O-ring, 1x8 mm	3	•		•		10
5	10.2033.16	Seal,16mm+O-ring, kalrez **	1					1	26	80.0212.84	Bushing, plast.	2		•			3
6	80.0211.51	Spacer ring, 16x41,8x8,8mm Sst.	1					2	27	80.0201.52	Manifold, Sst.	1					1
7	10.1021.00	Snap ring, d.20 mm Sst.	1		•			5	28	28.0014.53	Net, 38mesh-400µm Sst.	1					10
8	11.4420.42	Ball-bearing, 20x42x12 mm - 2RS1 Sst.	4		•			2	29	10.3208.36	O-ring, 2,62x36,17 mm Vi 70	1	•				5
9	10.1025.05	Snap ring, I 42 Sst.	1		•			5	30	80.0217.51	Coupl., M40x2 M -3/4F Bsp Sst.	1					1
10	10.3200.10	O-ring, 2,62x23,47 mm Vi 70	2	•				10	31	16.1955.60	Screw, DIN912 M8x60 mm Sst.	6					10
11	80.0135.52	Geared shaft end, Sst.	1					1	32	14.3573.00	Safet. washer, 8,4x2 mm Sst.	6					10
12	16.1870.02	Screw, DIN933 M5x12 mm Sst.	2					10	33	10.3109.93	O-ring, 2,4x8,3 mm Vi 70	3	•				10
13	80.0242.51	Pin, 24x85mm Sst.	1					1	34	80.0203.52	Turbine, Sst.	1					1
14	10.2050.05	V-ring seal, 45x5 mm	1	•				2	35	80.0213.84	Shim pin, plast.	3		•			3
15	16.1896.20	Screw, DIN912 M6x20 mm Sst.	3					10	36	80.0202.52	Stator, Sst.	1					1
16	80.0131.52	Pinion, z.39 Sst.	1					1	37	80.0204.38	Planetary gear, z.19 brz	9		•			3
17	10.3066.10	O-ring, 1,78x15,6 mm Vi 70	1					10	38	80.0205.00	Planetary gear holder+3 pins, Sst.	3					1
18	80.0243.51	Geared shaft, Sst.	1					1	39	25.4822.00	Protect. -A80 R -extnd nzl. **	1					1
19	10.2030.18	Stem seal, 18x23x2 mm +O-ring Epdm	1	•				5	40	80.0418.23	Xnd. nzl., sst. 07 1/4M Npt+guid.vane **	2-4					2
19	10.2035.18	Seal, 18mm -slid.block +O-ring, vit. (2) **	1					1	40	80.0420.23	Xnd. nzl., sst. 09 1/4M Npt+guid.vane **	2-4					2
19	10.2033.18	Seal, 18mm -slid.block +O-ring, kalrez **	1					1	40	80.0430.23	Xnd. nzl., sst. 20 1/4M Npt +guid.vane **	2-4					2
20	80.0207.52	Ring gear, z.50 Sst.	1					1	40	80.0440.23	Xnd. nzl., sst. 30 1/4M Npt +guid.vane	2-4					2
21	10.3080.58	O-ring, 1,78x56,87 mm Vi 70	2	•				10	41	16.1380.45	Nzl, sst,1/4M Npt+guid.vane 00.045 ***	2-4					10
22	80.0219.51	Plug, int.hex., M14x1 Sst.	3			•		3	42	14.6552.00	Teflon silicon grease x30g.>All **	1					2
23	10.3060.10	O-ring, 1,78x12,42 mm Vi 70	3	•		•		10	42	14.6550.00	Teflon grease x30g.>no Epdm **	1					2
24	80.0221.51	Injector, 2mm Sst. (3) **	3					3									

** On request

*** Different measures available

Kit	P/N	Description	
K1	25.4828.24	Seals Spares Kit - A80R 10x1pcs.	1
K2	25.4852.24	Spares Kit - A80R 7x1pcs.	1
K3	25.4810.40	A80 injector kit size 040, w/plug	1

(1) 25.4825.25 (2) 25.4826.60 (3) 25.4820.20 (4) 25.4820.25 (5) 25.4820.30 (6) 25.4820.40 (7) 25.4820.50 (8) 25.4820.60 (9) 25.4820.70 (10) 25.4820.80